

36路LED PWM驱动器

36-CHANNEL LED PWM DRIVER

■ FEATURES

- | | |
|---|--|
| <ul style="list-style-type: none"> · Input voltage range VCC: 2.5V to 5.5V · I²C interface, automatic address increment function · Four selectable I²C addresses · Internal soft reset register · Modulate LED brightness with 256 steps PWM · Each channel can be controlled independently · Each channel can be scaled independently by 1, 1/2, 1/3 and 1/4 · PWM frequency selectable - 3kHz (default) - 22kHz · Pb-free Packages, QFN44L-5×5 | <ul style="list-style-type: none"> · 输入电压范围VCC：2.5V-5.5V · I²C接口，支持连续写数据 · 4个I²C地址可选 · 内置软件复位寄存器 · 每路LED支持256阶 PWM亮度调节 · 36路 LED 独立控制 · 36路 LED 最大电流独立控制，4档可选 · 2档调制频率可选，3kHz(默认)和22kHz · QFN44L-5×5，无铅封装 |
|---|--|

■ APPLICATIONS

- | | |
|---|---|
| <ul style="list-style-type: none"> · Smart Speakers · Mobile phones and other hand-held devices for LED display · LED in home appliances | <ul style="list-style-type: none"> · Wireless Speakers · 智能音响 · 无线音响 · 带LED显示的手机和掌上设备 · 家电类LED显示 |
|---|---|

■ DESCRIPTION

HTR3236 is comprised of 36 constant current channels each with independent PWM control, designed for driving LEDs, PWM frequency can be 3kHz or 22kHz. The output current of each channel can be set at up to 38mA (Max.) by an external resistor and independently scaled by a factor of 1, 1/2, 1/3 and 1/4. The average LED current of each channel can be changed in 256 steps by changing the PWM duty cycle through an I²C interface.

The chip can be turned off by pulling the SDB pin low or by using the software shutdown feature to reduce power consumption.

HTR3236 is available in QFN-44L (5mm×5mm) packages. It operates from 2.5V to 5.5V over the temperature range of -40°C to +85°C.

HTR3236是一款36路LED PWM驱动器，PWM频率可固定为3kHz或22kHz。每一路最大输出电流可通过外置电阻R_{EXT}调节，最大38mA，并可独立控制4档可选。每一路可通过I²C单独控制256级细腻亮度调节。

主控器件通过I²C接口对HTR3236进行编程控制，通过将SDB脚拉低或软件设置可关断芯片，进入低功耗模式。

HTR3236使用QFN-44L(5mm×5mm)封装。工作电压在2.5V到5.5V，可在-40°C to +85°C工作。

■ ORDERING INFORMATION

Part Number	Package Type	Marking	Operating Temperature Range	MOQ/Shipping Package
HTR3236SQER	QFN44L-5×5	HTR3236 UVWXYZ	-40°C~85°C	Tape and Reel 5000PCS

■ TYPICAL APPLICATION

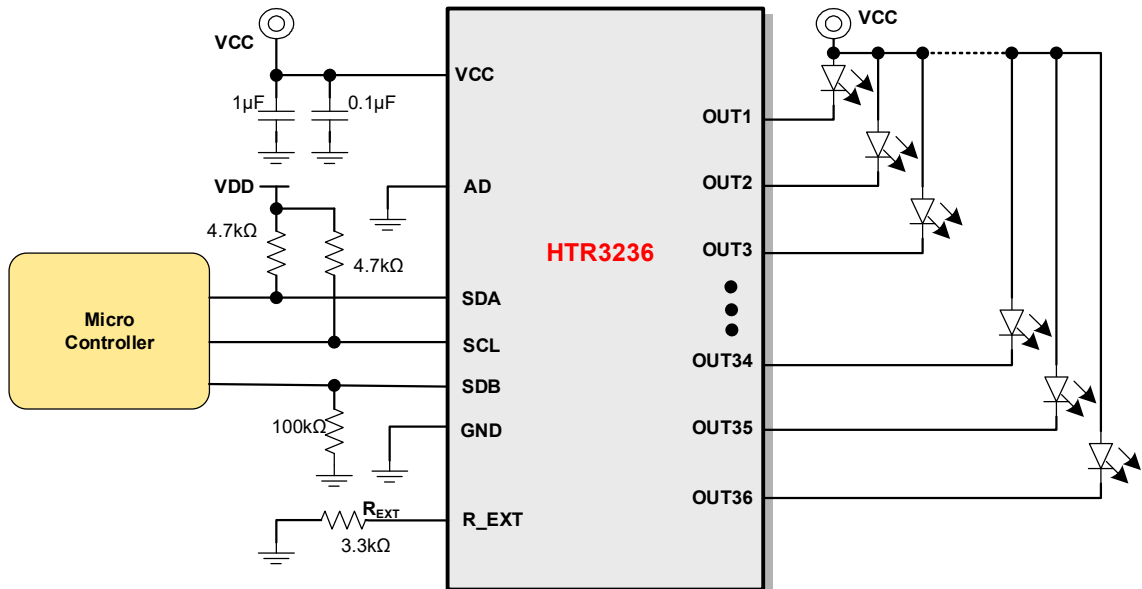

■ TERMINAL CONFIGURATION

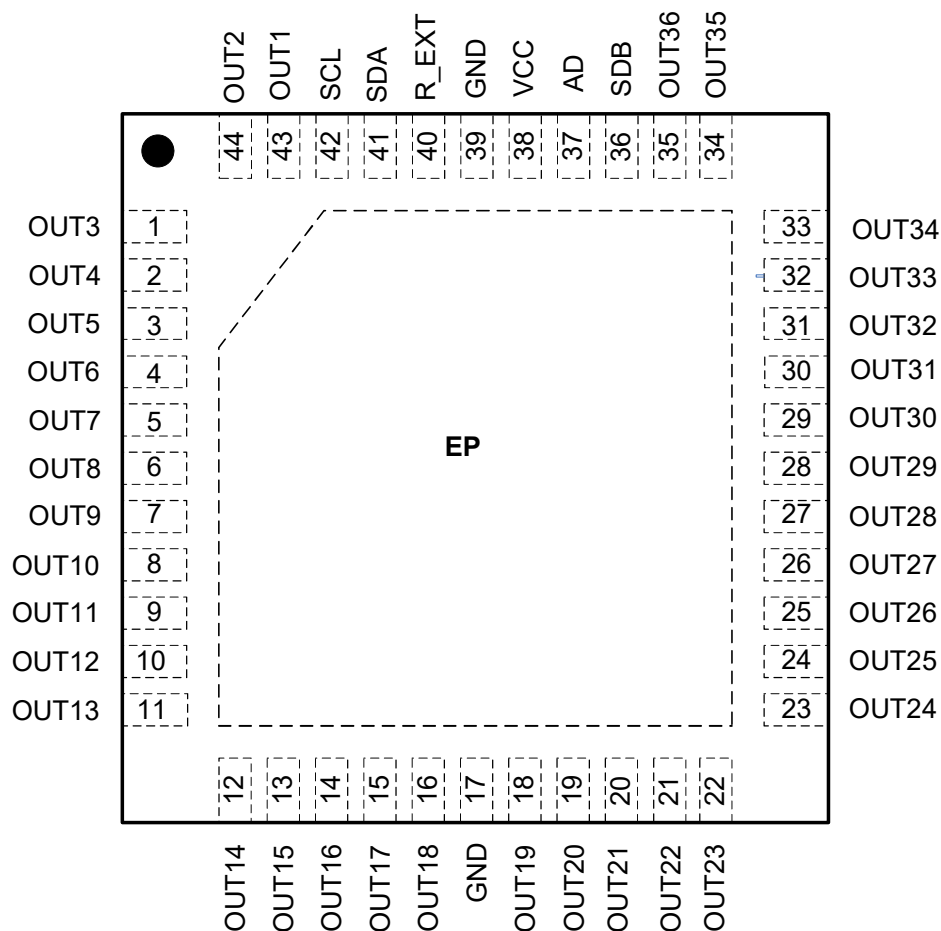

■ TERMINAL FUNCTION

Terminal No.	Name	Description
1~16	OUT3~OUT18	Output channel 3~18 for LEDs. 输出通道3~18
17, 39	GND	Ground. 地
18~35	OUT19~OUUT36	Output channel 19~36 for LEDs. 输出通道19~36
36	SDB	Shutdown the chip when pulled low. 关断芯片, 低电平有效。需接100k下拉电阻, 使开机默认为低电平的GPIO控制。芯片关断后, I ² C仍可对寄存器进行写操作。
37	AD	I ² C address setting. I ² C器件地址选择
38	VCC	Power supply. 电源输入端, 接0.1uF和1uF电容到地
40	R_EXT	Input terminal used to connect an external resistor. This regulates the global output current. 每一路通道最大电流I _{MAX} 控制引脚, 外接R _{EXT} 电阻到地, $I_{MAX} = 63.3 \times \frac{1.2V}{R_{EXT}}$
41	SDA	I ² C serial data. I ² C时钟, 需接上拉电阻 (建议4.7k), 1.8V/3.3V系统均可使用
42	SCL	I ² C serial clock. I ² C数据, 需接上拉电阻 (建议4.7k), 1.8V/3.3V系统均可使用
43,44	OUT1, OUT2	Output channel 1, 2 for LEDs. 输出通道1~2
EP	Exposed Thermal Pad	Connect to GND. 接地散热。

SPECIFICATIONS¹
Absolute Maximum Ratings²

PARAMETER	Symbol	MIN	TYP	MAX	UNIT
Power supply voltage for VCC	VCC	-0.3		6	V
Voltage at SCL, SDA, SDB, OUT1 to OUT36	V _I	-0.3		VCC+0.3	V
Moisture Sensitivity Level (MSL)			MSL3		
Ambient Operating Temperature	T _A	-40		85	°C
Junction Temperature	T _J	-65		150	°C
Storage Temperature	T _{STG}	-65		150	°C
Package thermal resistance, junction to ambient (4 layer standard test PCB based on JEDEC standard)	θ _{JA}		32.65		°C/W
ESD (HBM)			±8		kV
ESD (CDM)			±1		kV

Main Electrical Characteristics

 Condition: T_A = 25°C, VCC = 3.6V, unless otherwise specified

PARAMETER	Symbol	CONDITION	MIN	TYP	MAX	UNIT
Power supply voltage for VCC	VCC		2.5		5.5	V
Maximum global output current	I _{MAX}	VCC= 4.2V, V _{OUT} = 0.8V R _{EXT} = 2kΩ, SL= "00" ³		38		mA
Output current	I _{OUT}	V _{OUT} = 0.6V, R _{EXT} = 3.3kΩ, SL= "00"		23		mA
Headroom voltage	V _{HR}	R _{EXT} = 3.3kΩ, I _{OUT} = 20mA		0.4	0.6	V
Quiescent power supply current	I _{CC}	R _{EXT} = 3.3kΩ		10		mA
Shutdown current	I _{SD}	V _{SDB} = 0V or software shutdown		1.7	5	uA
PWM frequency of output	f _{OUT}	0x4B= 0x00		2.9		kHz
		0x4B= 0x01		21.6		kHz
Output leakage current	I _{OZ}	PWM=0, V _{OUT} = 5.5V			0.2	uA
Thermal shutdown	T _{SD}			160		°C
Thermal shutdown hysteresis	T _{SD_HYS}			20		°C
Output voltage of R_EXT pin	V _{EXT}			1.2		V

Logic Electrical Characteristics (SDA, SCL, SDB)

PARAMETER	Symbol	CONDITION	MIN	TYP	MAX	UNIT
Logic "0" input voltage	V _{IL}	VCC= 2.5V~5.5V			0.4	V
Logic "1" input voltage	V _{IH}	VCC= 2.5V~5.5V	1.4			V
Logic "0" input current	I _{IL}	V _{INPUT} = 0V		5		nA
Logic "1" input current	I _{IH}	V _{INPUT} = VCC		5		nA

¹ Depending on parts and PCB layout, characteristics may be changed.

² Stresses beyond those listed under absolute maximum ratings may cause permanent damage to the device. These are stress ratings only, and functional operation of the device at these or any other conditions beyond those indicated under recommended operating conditions is not implied. Exposure to absolute-maximum-rated conditions for extended periods may affect device reliability.

³ The recommended minimum value of R_{EXT} is 2kΩ, or it may cause a large current.

● I²C Control Port

PARAMETER	Symbol	MIN	TYP	MAX	UNIT
Serial-Clock frequency	f_{SCL}			400	kHz
Bus free time between a STOP and a START condition	t_{BUF}	1.3			us
Hold time (repeated) START condition. After this period, the first clock pulse is generated.	$t_{h(STA)}$	0.6			us
Setup time for a repeated START condition	$t_{su(STA)}$	0.6			us
Setup Time for SCL to STOP condition	$t_{su(STO)}$	0.6			us
Data hold time	$t_{h(DAT)}$	0		0.9	us
Setup Time, SDA to SCL	$t_{su(DAT)}$	100			ns
Required Pulse Duration, SCL HIGH	t_{HIGH}	0.7			us
Required Pulse Duration, SCL LOW	t_{LOW}	1.3			us
Rise Time, SCL and SDA	T_r			300	ns
Fall Time, SCL and SDA	T_f			300	ns

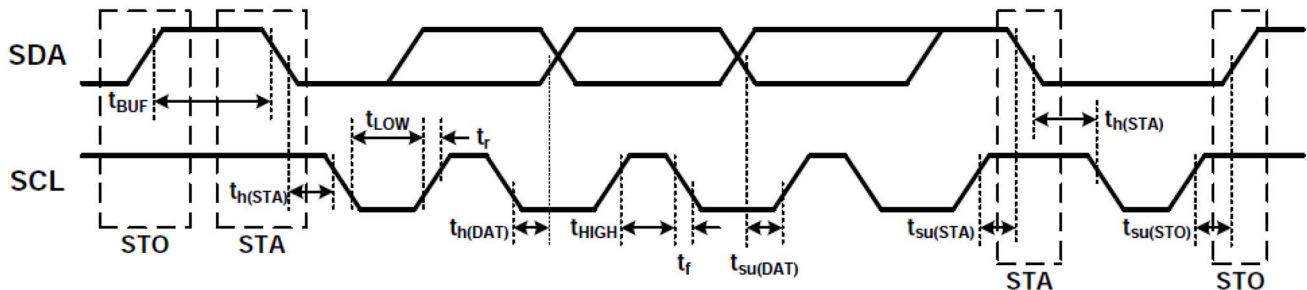

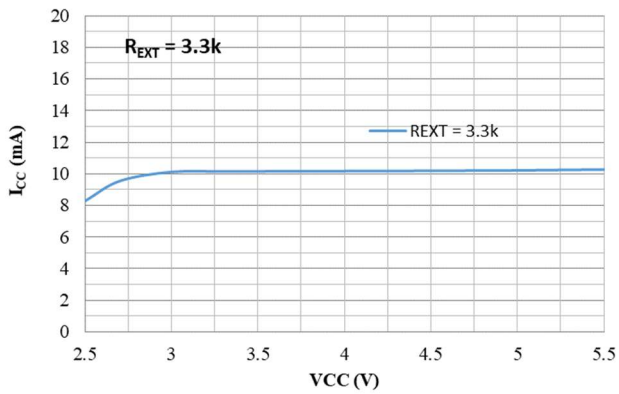
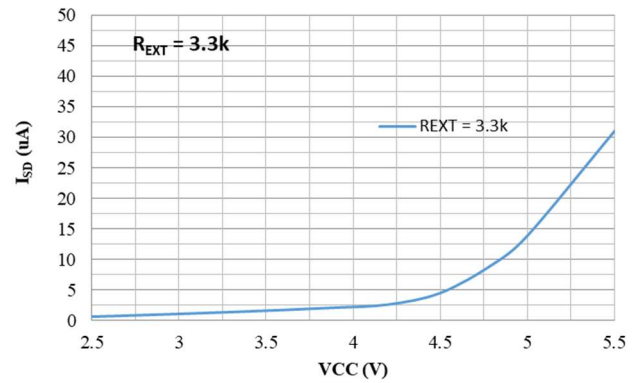
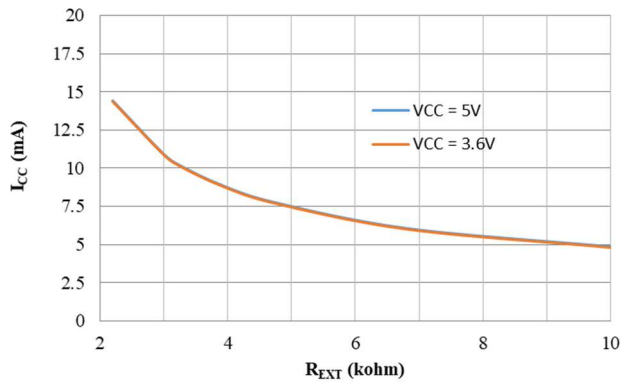
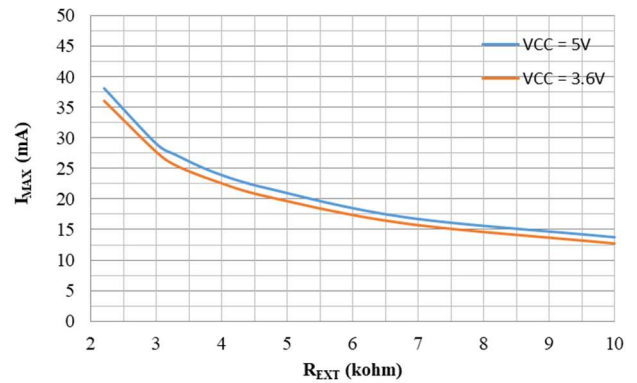
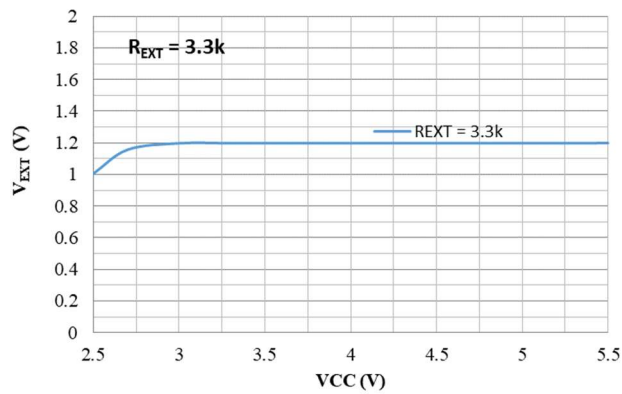
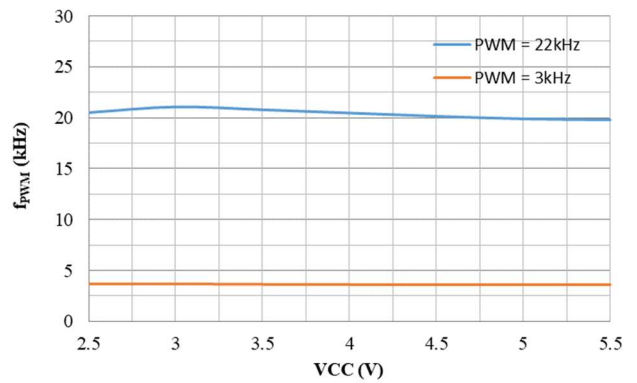
TYPICAL OPERATING CHARACTERISTICS
 V_{CC} vs I_{CC}

 V_{CC} vs I_{SD}

 R_{EXT} vs I_{CC}

 R_{EXT} vs I_{MAX}

 V_{CC} vs V_{EXT}

 V_{CC} vs f_{PWM}

APPLICATION INFORMATION

1 I²C INTERFACE

The HTR3236 uses a serial bus, which conforms to the I²C protocol, to control the chip's functions with two wires: SCL and SDA. The chip has a 7-bit slave address (A7:A1), followed by the R/W bit, A0.

Since HTR3236 only supports write operations, A0 must always be "0". The value of bits A1 and A2 are decided by the connection of the AD pin.

The complete slave address is:

Table1 Slave Address (Write only)

Bit	A7:A3	A2:A1	A0
Value	01111	AD	0

AD connected to GND, AD = 00; AD connected to VCC, AD = 11; AD connected to SCL, AD = 01; AD connected to SDA, AD = 10;

The SCL line is uni-directional. The SDA line is bi-directional (open-collector) with a pull-up resistor (typically 4.7kΩ). The maximum clock frequency specified by the I²C standard is 400kHz. In this discussion, the master is the microcontroller and the slave is the HTR3236.

The "START" signal is generated by lowering the SDA signal while the SCL signal is high. The start signal will alert all devices attached to the I²C bus to check the incoming address against their own chip. The 8-bit chip address is sent next, most significant bit first. Each address bit must be stable while the SCL level is high. address.

The 8-bit chip address is sent next, most significant bit first. Each address bit must be stable while the SCL level is high.

After the last bit of the chip address is sent, the master checks for the HTR3236's acknowledge. The master releases the SDA line high (through a pull-up resistor). Then the master sends an SCL pulse. If the HTR3236 has received the address correctly, then it holds the SDA line low during the SCL pulse. If the SDA line is not low, then the master should send a "STOP" signal (discussed later) and abort the transfer.

Following acknowledge of HTR3236, the register address byte is sent, most significant bit first. HTR3236 must generate another acknowledge indicating that the register address has been received.

Then 8-bit of data byte are sent next, most significant bit first. Each data bit should be valid while the SCL level is stable high. After the data byte is sent, the HTR3236 must generate another acknowledge to indicate that the data was received.

The "STOP" signal ends the transfer. To signal "STOP", the SDA signal goes high while the SCL signal is high.

HTR3236 使用两条符合 I²C 通信协议的串行传输线 SDA 和 SCL 来控制芯片的工作方式。HTR3236 使用 8 位的从地址 (A7:A0)，只支持写操作，A0 为写位，为 0；A1 和 A2 位由 AD 引脚的连接来决定。

完整的地址为：

AD连接至GND, AD = 00; AD连接至VCC, AD = 11; AD连接至SCL, AD = 01; AD连接至SDA, AD = 10;

I²C 总线支持数据双向传输。SCL 为单向端口；SDA 为双向端口，开漏输出驱动，需外接上拉电阻（典型值为 4.7k）。最大时钟频率为 400kHz。在这种情况下，主控制器为单片机等控制器，从器件为 HTR3236。

“开始”信号由 SCL 为高电平时将 SDA 拉低产生。“停止”信号表示结束数据的传送，当 SCL 信号为高电平时，将 SDA 拉高就产生了停止信号。

在 SCL 为稳定的高电平时，SDA 为闭锁状态，并且在不使用的时候应保持高电平。除了起始条件和停止条件以外，SDA 只能在 SCL 为低时才能改变。当 SCL 为高电平时，SDA 上的每个地址为必须保持稳定。

数据传输时，首先传送 8 位的器件地址。在最后一位传送出去后，主控制器应检测 HTR3236 的应答信号。主控制器通过上拉电阻释放 SDA 为高电平，然后使 SCL 发送一个脉冲。如果 HTR3236 正确的接收到 8 位数据，在 SCL 的脉冲期间它将使 SDA 拉低；如果 SDA 线不为低，则表示数据没有正确接收，主控制器将会发送一个“停止”信号并且中断数据传递。

在 HTR3236 的应答信号发送之后，寄存器的地址将被发送。寄存器地址发出后，HTR3236 也必须产生一个应答位来表示寄存器地址已被正确接收。

接下来传送的是 8 位的寄存器数据。在 SCL 保持稳定的高电平时每位数据都是有效的。8 位数据传送完后，HTR3236 同样需要产生一个应答位来表示数据的正确接收。

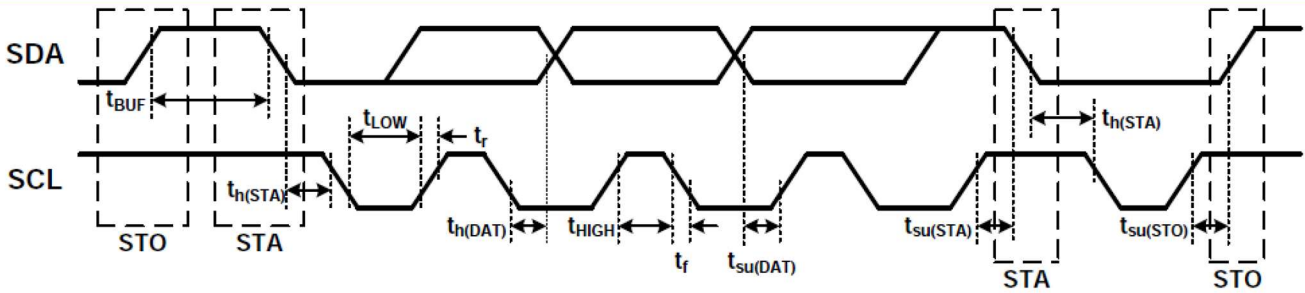

Figure 1 I²C Interface Timing

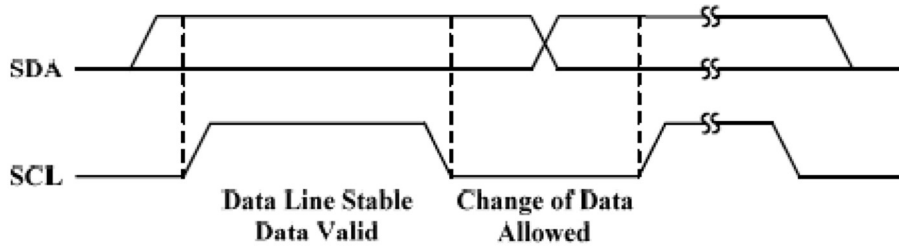

Figure 2 Bit Transfer

ADDRESS AUTO INCREMENT

To write multiple bytes of data into HTR3236, load the address of the data register that the first data byte is intended for. During the HTR3236 acknowledge of receiving the data byte, the internal address pointer will increment by one. The next data byte sent to HTR3236 will be placed in the new address, and so on. The auto increment of the address will continue as long as data continues to be written to HTR3236 (Figure 4).

如果有多个数据要传送给 HTR3236，只需发送第一个数据写入的寄存器地址。在 HTR3236 接收数据器件，寄存器地址会自动加 1，下一个传送的数据将写入新的寄存器地址中，如此继续，直到 I²C 写入“停止”信号。如下图 4。

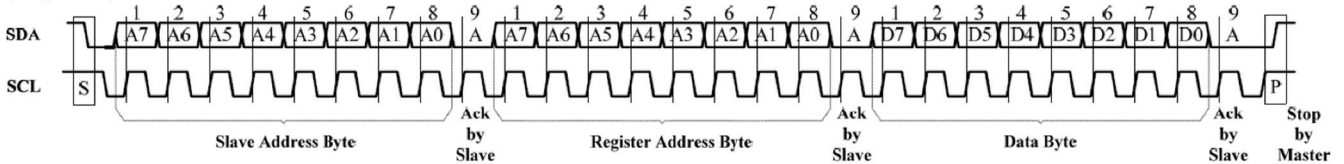

Figure 3 Typical I²C Writing

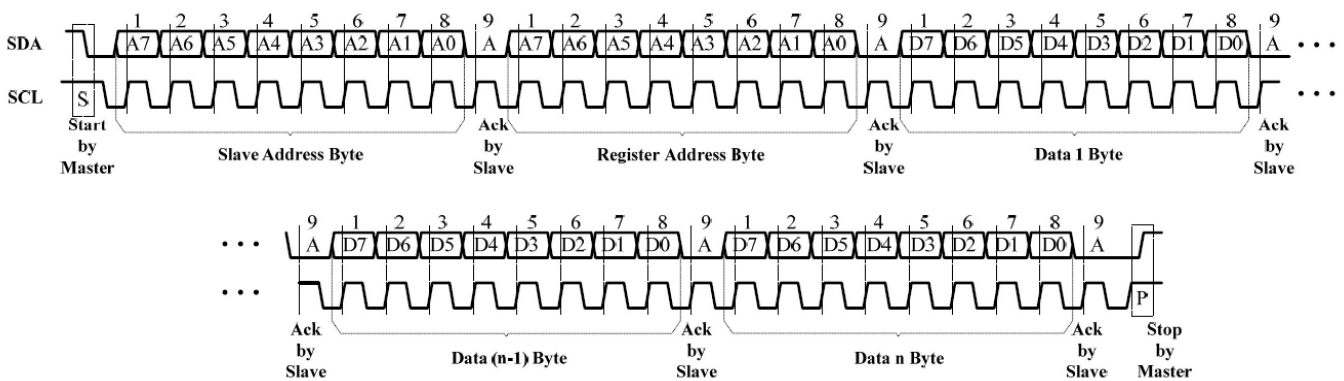

Figure 4 I²C Writing with Automatic Address Increment

2 Register Map

Table2 Register Map

Register Address	Name	Function	Default Value
00h	Shutdown	Set software shutdown mode 软件设置关断	0000 0000
01h~24h	PWM	36 channels PWM duty cycle data register 储存 36 路 LED 的 PWM 亮度值	0000 0000
25h	PWM Update	Load PWM Register and LED Control Register's data 更新 PWM 寄存器和 LED 控制寄存器的数据	xxxx xxxx
26~49h	LED Control	Channel 1 to 36 enable bit and current setting 设置 36 路 LED 的开关状态和电流调节	0000 0000
4Ah	Global Control	Set all channels enable 全局设置所有 LED 的开关状态	0000 0000
4Bh	Output Frequency Setting	Set all channels operating frequency 设置所有 LED 通道频率	0000 0000
4Fh	Reset	Reset all registers into default value 重置所有寄存器数据为默认值	xxxx xxxx

Register Address: 00h, Shutdown Register (default 0000 0000)

Bit	Label	Default	Description
D7:D1	Reserved	0000000	Unused, make it always 0000000
D0	Shutdown	0	0: Software shutdown mode 1: Normal operation

Register Address: 01h~24h, PWM Register OUT1~OUT36 (default 00000000)

Bit	Label	Default	Description
D7:D0	PWM	00000000	<p>The PWM Registers adjusts LED luminous intensity in 256 steps. 该 PWM 寄存器对每路 LED 亮度设置 256 级细腻调节。</p> <p>The value of a channel's PWM Register decides the average output current for each output, OUT1~OUT36. The average output current may be computed using: PWM 寄存器设置每路输出电流的平均值, 电流平均值可由以下公式计算:</p> $I_{PWM} = \frac{I_{OUT}}{256} \times \sum_{n=0}^7 D[n] \times 2^n$ <p>Where "n" indicates the bit location in the respective PWM register. For example: D7:D0 = 10110101, $I_{OUT} = I_{MAX} (2^0+2^2+2^4+2^5+2^7)/256$</p> <p>The I_{OUT} of each channel is setting by the SL bit of LED Control Register (26h~49h). Please refer to the detail information in Page 11. I_{OUT} 由 LED 控制寄存器(26h~49h)设置。</p>

Register Address: 25h, PWM Update Register

Bit	Label	Default	Description
D7:D0	PWM Update	/	<p>The data sent to the PWM Registers and the LED Control Registers will be stored in temporary registers. A write operation of "0000 0000" value to the Update Register is required to update the registers (01h~24h, 26h~49h). 发送给 PWM 寄存器 (01h~24h) 和 LED 控制寄存器 (26h~49h) 的数据会被存储到临时寄存器里。写入 0000 0000 或任意数据到该 PWM 更新寄存器, 可是 PWM 寄存器和 LED 控制寄存器的配置生效。</p>

Register Address: 26h~49h, LED Control Register OUT1~OUT36 (default 00000000)

Bit	Label	Default	Description
D7:D3	Reserved	00000	Unused, make it always 00000
D2:D1	SL	00	Output Current Setting I_{OUT} 电流输出 (I_{OUT}) 设置位: 00: 该路输出电流为 I_{MAX} 01: 该路输出电流为 $I_{MAX}/2$ 10: 该路输出电流为 $I_{MAX}/3$ 11: 该路输出电流为 $I_{MAX}/4$
D0	OUT	0	LED State LED 开关使能: 0: LED off. 该路 LED 关闭 1: LED on. 该路 LED 开启

Register Address: 4Ah, Global Control Register (default 00000000)

Bit	Label	Default	Description
D7:D1	Reserved	0000000	Unused, make it always 0000000
D0	G_EN	0	Global LED Enable 全局 LED 使能位: 0: Normal operation. 标准工作模式 1: Shutdown all LEDs. 36 路 LED 同时关闭

Register Address: 4Bh, Output Frequency Setting Register (default 00000000)

Bit	Label	Default	Description
D7:D1	Reserved	0000000	Unused, make it always 0000000
D0	OFS	0	The Output Frequency Setting Register selects a fixed PWM operating frequency for all output channels. 设置 36 路 LED 输出频率: 0: 3kHz 1: 22kHz

Register Address: 4Fh, Reset Register

Bit	Label	Default	Description
D7:D0	Reset	/	Once user writes "0000 0000" data to the Reset Register, HTR3236 will reset all registers to default value. On initial power-up, the HTR3236 registers are reset to their default values for a blank display. 写入 00000000 或任意数据到该复位寄存器, HTR3236 的所有寄存器数据重置为默认值。在初始上电时, HTR3236 的寄存器数据也将被复位成默认值。

3 Typical Application

3.1 PWM Control

The PWM Registers (01h~24h) can modulate LED brightness of 36 channels with 256 steps. For example, if the data in PWM Register is “0000 0100”, then the PWM is the fourth step.

Writing new data continuously to the registers can modulate the brightness of the LEDs to achieve a breathing effect.

3.2 R_{EXT} Setting

The maximum output current of OUT1~OUT36 can be adjusted by the external resistor, R_{EXT}, as described in Formula:

$$I_{MAX} = x \times \frac{V_{EXT}}{R_{EXT}}$$

x = 63.3, V_{OUT} = 0.8V, V_{EXT} = 1.2V

The recommended minimum value of R_{EXT} is 2kΩ.

3.3 Current Setting

The current of each LED can be set independently by the SL bit of LED Control Register (26h~49h). The maximum global current is set by the external register R_{EXT}.

When channels drive different quantity of LEDs, adjust maximum output current according to quantity of LEDs to ensure average current of each LED is the same.

For example, set R_{EXT} = 3.3kΩ then I_{MAX} = 23mA. If OUT1 drives two LEDs and OUT2 drives four LEDs, set the SL bit of LED Control Register (26h) to “01” and SL bit of LED Control Register (27h) to “00”. So the current of OUT1 is I_{OUT1} = I_{MAX}/2 = 11.5mA and the current of OUT2 is I_{OUT2} = I_{MAX} = 23mA. The average current of each LED is the same.

3.4 Gamma Correction

In order to perform a better visual LED breathing effect we recommend using a gamma corrected PWM value to set the LED intensity. This results in a reduced number of steps for the LED intensity setting, but causes the change in intensity to appear more linear to the human eye.

Gamma correction, also known as gamma compression or encoding, is used to encode linear luminance to match the non-linear characteristics of display. Since the HTR3236 can modulate the brightness of the LEDs with 256 steps, a gamma correction function can be applied when computing each subsequent LED intensity setting such that the changes in brightness matches the human eye's brightness curve.

Choosing more gamma steps provides for a more continuous looking breathing effect. This is useful for long reathing cycles. The recommended configuration is defined by the breath cycle T. When T=1s, choose 32 gamma steps, when T=2s, choose 64 gamma steps. The user must decide the final number of gamma steps not only by the LED itself, but also based on the visual performance of the finished product.

通过设置 PWM 寄存器(01h~24h)来调节 36 路 LED 的亮度值。如在 PWM 寄存器中写入 “0000 0100”，则输出为第 4 级亮度。

连续写入数据使 PWM 亮度逐渐升高或降低，即可实现 LED 呼吸效果。

HTR3236 的 36 路最大输出电流可通过外接电阻 R_{EXT} 设置，计算公式如下：

$$I_{MAX} = x \times \frac{V_{EXT}}{R_{EXT}}$$

x = 63.3, V_{OUT} = 0.8V, V_{EXT} = 1.2V

R_{EXT} 推荐使用的最小阻值为 2kohm。

HTR3236 可通过设置 LED 控制寄存器 (26h~49h)的 SL 位来调节每路 LED 的电流值。每路的最大电流与由外接电阻 R_{EXT} 决定，通过 SL 位可独立的设置每路 LED 的电流。

当各路输出驱动 LED 个数不同时，可根据 LED 的个数选择该路输出的最大电流，使每颗 LED 的平均电流保持一致。

例如，当 R_{EXT} = 3.3kΩ 时，I_{MAX} = 23mA，若 OUT1 外接 2 颗 LED，OUT2 外接 4 颗 LED，为使 6 颗 LED 的平均电流相同，可设置 26h 寄存器的 SL 位为 “01”，27h 寄存器的 SL 位为 “00”，则 OUT1 的电流为 I_{OUT1} = I_{MAX}/2 = 11.5mA，OUT2 的电流为 I_{OUT2} = I_{MAX} = 23mA。

使用 HTR3236 实现 LED 呼吸效果时，为得到更好的呼吸效果，建议对呼吸控制进行非线性修正。

HTR3236 内部实现线性的 256 级 PWM 调光。由于人视觉对亮度的误差，电流线性增加时，视觉上会感觉到呼吸开始时亮度变化快，然后很快进入亮度饱和的问题。为了解决这个问题，在呼吸时，引入伽马补偿的方法，达到视觉效果的线性。

为了显示更细腻的效果，可采取更多级的输出，防止呼吸时产生可观察到的亮度跳变。推荐的经验值是，从最暗到最亮的呼吸周期 T 内，当 T=1s，推荐伽马补偿 32 级；当 T=2s，推荐伽马补偿 64 级，以此类推。此推荐是 LED 没有任何遮挡下的经验值。若 LED 有挡光板，可采用更少的亮度登记实现。具体等级数，可根据实际测试调节。

Table3 32 Gamma Steps With 256 PWM Steps

C(0)	C(1)	C(2)	C(3)	C(4)	C(5)	C(6)	C(7)
0	1	2	4	6	10	13	18
C(8)	C(9)	C(10)	C(11)	C(12)	C(13)	C(14)	C(15)
22	28	33	39	46	53	61	69
C(16)	C(17)	C(18)	C(19)	C(20)	C(21)	C(22)	C(23)
78	86	96	106	116	126	138	149
C(24)	C(25)	C(26)	C(27)	C(28)	C(29)	C(30)	C(31)
161	173	186	199	212	226	240	255

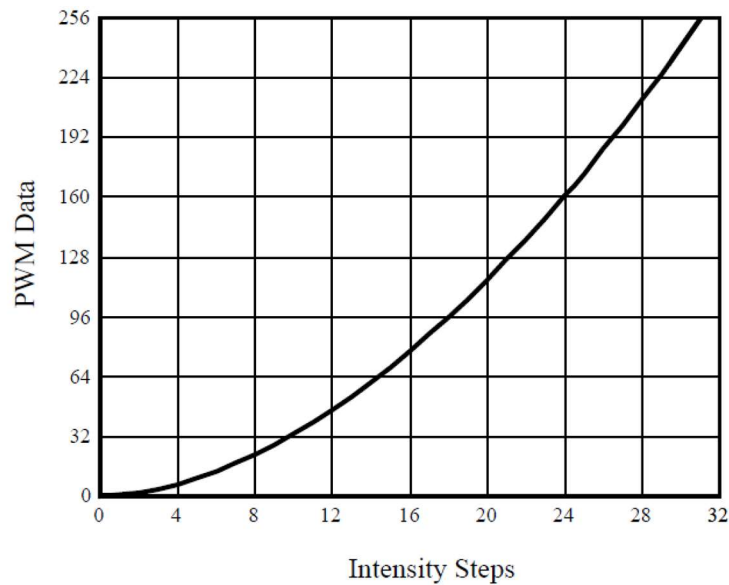

Figure 5 Gamma Correction (32 Steps)

Table4 64 Gamma Steps With 256 PWM Steps

C(0)	C(1)	C(2)	C(3)	C(4)	C(5)	C(6)	C(7)
0	1	2	3	4	5	6	7
C(8)	C(9)	C(10)	C(11)	C(12)	C(13)	C(14)	C(15)
8	10	12	14	16	18	20	22
C(16)	C(17)	C(18)	C(19)	C(20)	C(21)	C(22)	C(23)
24	26	29	32	35	38	41	44
C(24)	C(25)	C(26)	C(27)	C(28)	C(29)	C(30)	C(31)
47	50	53	57	61	65	69	73
C(32)	C(33)	C(34)	C(35)	C(36)	C(37)	C(38)	C(39)
77	81	85	89	94	99	104	109
C(40)	C(41)	C(42)	C(43)	C(44)	C(45)	C(46)	C(47)
114	119	124	129	134	140	146	152
C(48)	C(49)	C(50)	C(51)	C(52)	C(53)	C(54)	C(55)
158	164	170	176	182	188	195	202
C(56)	C(57)	C(58)	C(59)	C(60)	C(61)	C(62)	C(63)
209	216	233	230	237	244	251	255

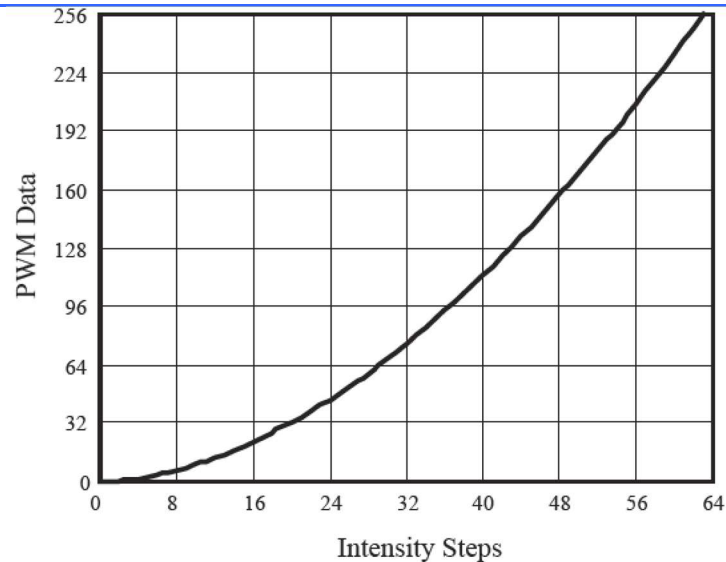

Figure 6 Gamma Correction (64 Steps)

3.5 Shutdown Mode

Shutdown mode can be used as a means of reducing power consumption. During shutdown mode all registers retain their data.

芯片关断模式可用于减少功耗。在芯片关断模式下，所有寄存器保持原数据不变。

Software Shutdown

By setting shutdown bit of the Shutdown Register (00h) to “0” the device will operate in software shutdown mode. When the device is in software shutdown mode, all current sources are switched off.

通过对关断寄存器（00h）中 Shutdown 位置 “0”，芯片进入软件关断模式，所有的电流输出端口关闭。

Hardware Shutdown

The chip enters hardware shutdown when the SDB pin is pulled low. All analog circuits are disabled during hardware shutdown, typical the current consume is 3 μ A.

当 SDB 脚拉低时，芯片进入硬件关断模式。

The chip releases hardware shutdown when the SDB pin is pulled high. When set SDB high, the rising edge will reset the I²C module, but the register information retains. During hardware shutdown state Function Register can be operated.

3.6 PWM Frequency Select

The HTR3236 output channels operate with a default PWM frequency of 3kHz. Because all the OUTx channels are synchronized, the DC supply will experience large instantaneous current surges when the OUTx channels turn ON. These current surges will generate an AC ripple on the power supply which cause stress to the decoupling capacitors.

HTR3236的默认输出PWM频率为3kHz，由于所有输出都是同步的，DC电源会引入瞬间浪涌电流，从而导致电源端引入AC纹波。

When the AC ripple is applied to a monolithic ceramic capacitor chip (MLCC) it will expand and contract causing the PCB to flex and generate audible hum in the range of between 20Hz to 20kHz, To avoid this hum, there are many countermeasures, such as selecting the capacitor type and value which will not cause the PCB to flex and contract.

由于该3kHz频率是可闻频率，PCB系统可能会产生可闻噪声。避免该噪声的一种方法是尝试使用不同材质和电容值的滤波电容。

An additional option for avoiding audible hum is to set the HTR3236's output PWM frequency above the audible range. The Output Frequency Setting Register (4Bh)'s bit D0 can be used to set the switching frequency to 22kHz, which is beyond the audible range. Figure 7 below shows the variation of output PWM frequency across supply voltage and temperature.

另一种方式是使用更高的不可闻频率。4Bh 寄存器输出频率设置寄存器的 D0 位可设置频率输出为 22kHz。下图是不同电源电压和温度下的 PWM 频率曲线。

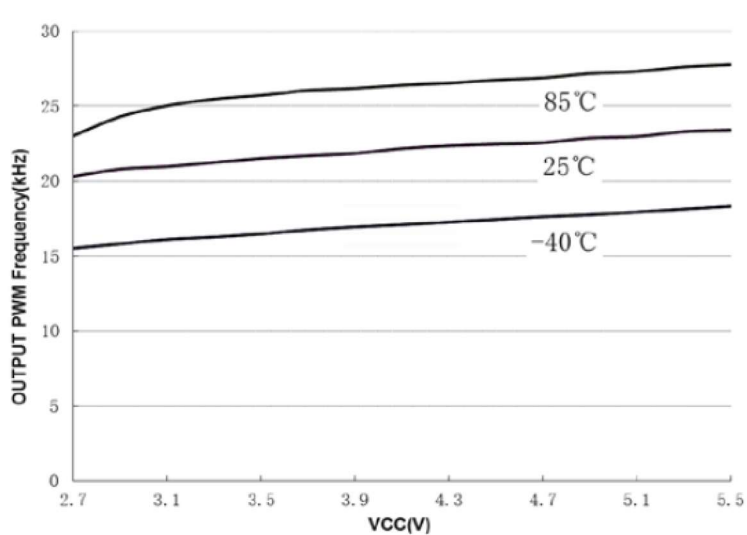
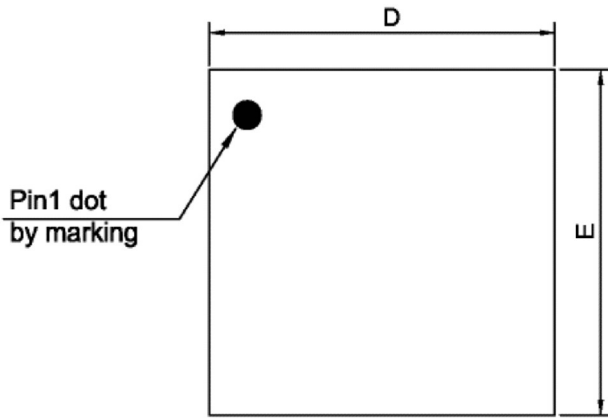
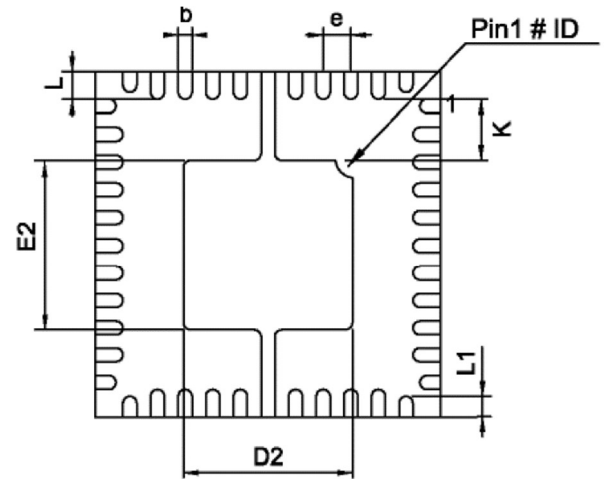

Figure 7 VCC vs. Output PWM Frequency

PACKAGE OUTLINE

TOP VIEW



BOTTOM VIEW

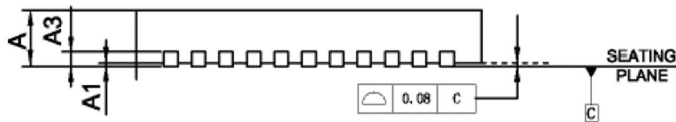

SIDE VIEW

SYMBOL	MILLIMETER		
	MIN	NOM	MAX
A	0.70	0.75	0.80
A1	0.00	—	0.05
A3	0.20REF		
D	4.90	5.00	5.10
E	4.90	5.00	5.10
E2	2.30	2.45	2.55
D2	2.30	2.45	2.55
b	0.15	0.20	0.25
L	0.30	0.40	0.50
L1	0.20	0.30	0.40
K	0.20	—	—
e	0.40BSC		

NOTES:

1. CONTROLLING DIMENSION:MM
2. REFERENCE DOCUMENT:NA CLOSE TOOL
3. THE PIN'S SHARP AND THERMAL PAD SHOWS DIFFERENT SHARP AMONG DIFFERENT FACTORIES.

IMPORTANT NOTICE**注意**

Jiaxing Heroic Electronic Technology Co., Ltd (HT) reserves the right to make corrections, modifications, enhancements, improvements, and other changes to its products and services at any time and to discontinue any products or services. Customers should obtain the latest relevant information before placing orders and should verify that such information is current and complete.

嘉兴禾润电子科技有限公司（以下简称HT）保留对产品、服务、文档的任何修改、更正、提高、改善和其他改变，或停止提供任何产品和服务的权利。客户在下单和生产前应确保所得到的信息是最新、最完整的。

HT assumes no liability for applications assistance or customer product design. Customers are responsible for their products and applications using HT components.

HT对相关应用的说明和协助以及客户产品的板级设计不承担任何责任。

HT products are not authorized for use in safety-critical applications (such as life support devices or systems) where a failure of the HT product would reasonably be expected to affect the safety or effectiveness of that devices or systems.

HT的产品并未授权用于诸如生命维持设备等安全性极高的应用中。

The information included herein is believed to be accurate and reliable. However, HT assumes no responsibility for its use; nor for any infringement of patents or other rights of third parties which may result from its use.

本文中的相关信息是精确和可靠的，但HT并不对其负责，也不对任何可能的专利和第三方权利的侵害负责。

Following are URLs and contacts where you can obtain information or supports on any HT products and application solutions:

下面是可以联系到我公司的相关链接和联系方式：

嘉兴禾润电子科技有限公司**Jiaxing Heroic Electronic Technology Co., Ltd.**

地址：浙江省嘉兴市凌公塘路3339号JRC大厦A座三层

Add: A 3rd floor, JRC Building, No. 3339, LingGongTang Road, Jiaxing, Zhejiang Province

Sales: 0573-82585539, sales@heroic.com.cn

Support: 0573-82586151, support@heroic.com.cn

Fax: 0573-82585078

Website: www.heroic.com.cn; wap.heroic.com.cn

Wechat MP: HEROIC_JX

请及时关注禾润官方微信公众号，随时获取最新产品信息和技术资料！

